

SAE PUMP AND MOTOR MOUNTING FLANGE AND SHAFT DIMENSIONS

SAE Straight (keyed) Shafts

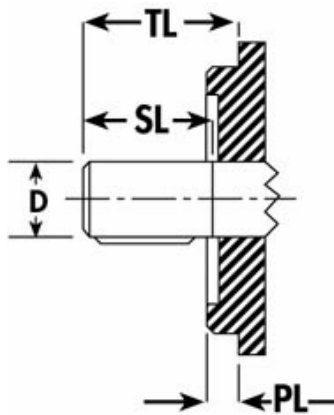

SAE Code	Shaft DIA (D)	Shaft Length (SL)	Total Length (TL)	Key Width
AA	0.500	0.750	1.062	0.125
A	0.625	0.937	1.250	0.156
AH	0.750	0.937	1.250	0.187
B	0.875	1.312	1.625	0.250
BB	1.000	1.500	1.812	0.250
C	1.250	1.875	2.187	0.312
CC	1.500	2.125	2.437	0.375
D	1.750	2.625	2.937	0.437
E	1.750	2.625	2.937	0.437

Hydraulic Secrets Revealed! www.InsiderSecretsToHydraulics.com

SAE 30° Involute Spline Shafts

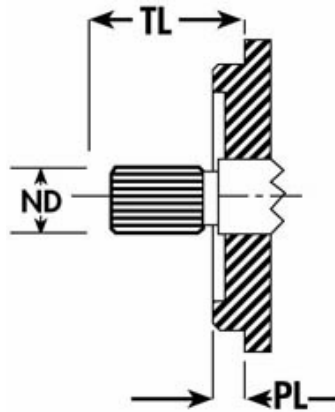

SAE Code	Spline Details	Nominal DIA (ND)	Total Length (TL)
AA	9T 20/40 DP	0.500	1.062
A	9T 16/32 DP	0.625	1.250
AH	11T 16/32 DP	0.750	1.490
B	13T 16/32 DP	0.875	1.625
BB	15T 16/32 DP	1.000	1.812
C	14T 12/24 DP	1.250	2.187
CS	21T 16/32 DP	1.375	2.187
CC	17T 12/24 DP	1.500	2.437
D	13T 8/16 DP	1.750	2.937
E	13T 8/16 DP	1.750	2.937
F	15T 8/16 DP	2.000	3.437

Hydraulic Secrets Revealed! www.InsiderSecretsToHydraulics.com

SAE Two Bolt Mounting Flange

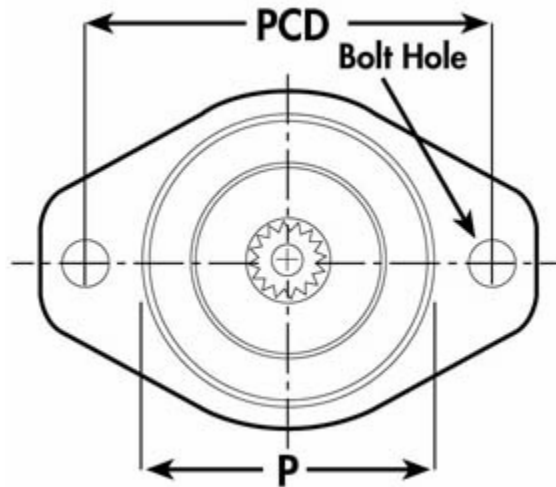

SAE Code	Bolt PCD	Bolt Hole DIA	Pilot DIA (P)	Pilot Length (PL)
AA	3.250	0.406	2.00	0.250
A	4.187	0.437	3.25	0.250
B	5.750	0.562	4.00	0.375
C	7.125	0.687	5.00	0.500
D	9.000	0.812	6.00	0.500
E	12.500	1.062	6.50	0.625
F	13.781	1.062	7.00	0.625

Hydraulic Secrets Revealed! www.InsiderSecretsToHydraulics.com

SAE Four Bolt Mounting Flange

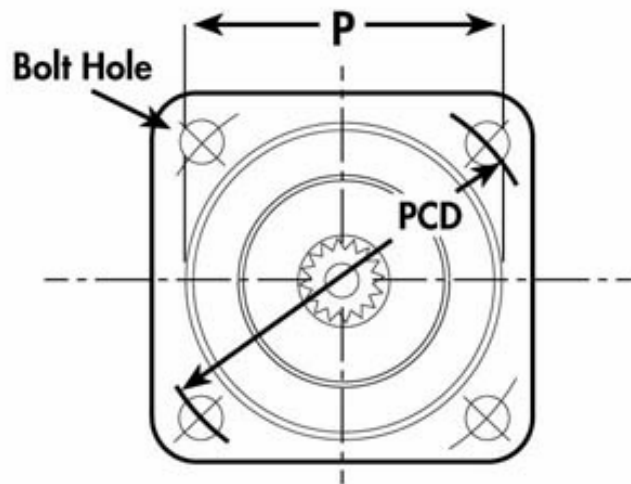

SAE Code	Bolt PCD	Bolt Hole DIA	Pilot DIA (P)	Pilot Length (PL)
B	5.000	0.562	4.00	0.375
C	6.375	0.562	5.00	0.500
D	9.000	0.812	6.00	0.500
E	12.500	0.812	6.50	0.625
F	13.781	1.062	7.00	0.625

Hydraulic Secrets Revealed! www.InsiderSecretsToHydraulics.com